

Article number: 203150M1675B2TK
 Description: E+G levelling foot
 GN 31-50-M16-75-B2-TK
 Note: TK With nut, Wrench flat at the bottom

Measures

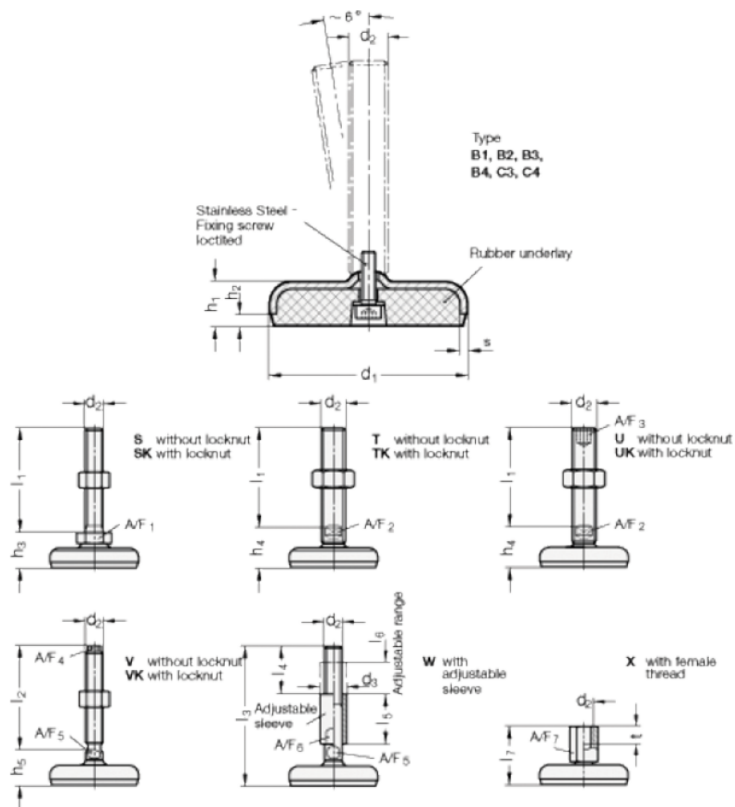

A/F2	= 12
d1	= 50
d2	= 16
h1	= 16
h2	= 3.5
h4 +4.0/0	= 29
l2	= 75
s	= 3